

Classic Styling in a Compact Bath

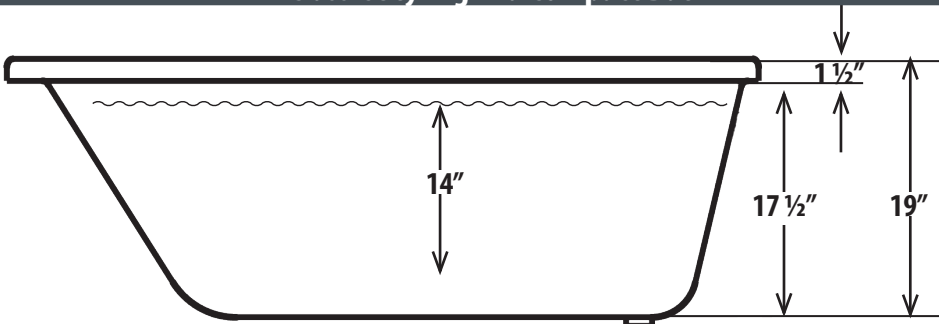

Maximum Water Depth = 14"

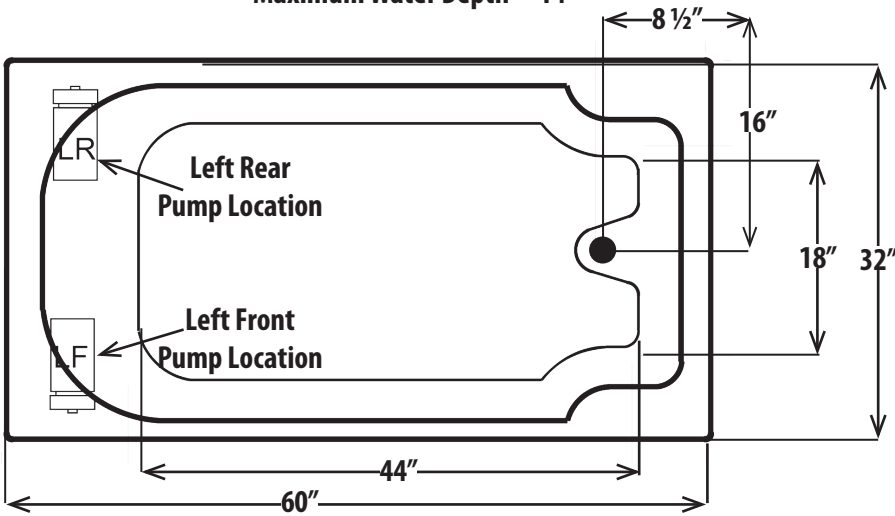

SPECIFICATIONS

Size	60" L x 32" W	Overall Height: 19"	Height to Base of Lip: 17 1/2"
Interior Dimensions	44" L x 18" W	Maximum Water Height: 14"	Drain Location: End
Average Gallon Capacity : 60	Installation Type: Drop In	Long End to Drain Center: 16"	Short End to Drain Center: 8 1/2"
Material	Extra Thick High Gloss Lucite® Acrylic with Zero Flex Bottom		
Colors	White, Biscuit, Bone, Almond, Mexican Sand, Sterling Silver, Red & Black		
<b>Electrical Requirements for Luxury Whirlpool, Luxury Air &amp; Luxury Plus (Soaking baths do not require electrical connection)</b>			
Heat Stick	No Electricity Required - Water temperature is maintained when pump is on (NOT AVAILABLE ON AIR BATHS)		
Pump / Blower	Single dedicated 120V 20 AMP GFCI protected circuit for both Luxury & Luxury Plus Baths		
Optional In-Line Heater	Requires installation of additional dedicated 120V 15 AMP GFCI protected circuit		
<b>Bath Features</b>			
Whirlpool Bath	8 Hydrotherapy Jets in either white or almond, Pump, Heat Stick, Push Button Controls		
Air Bath	15 Air Injection Jets in either white or almond, Heated Blower, Push Button Controls		
Luxury Whirlpool Bath	Whirlpool Bath with Tranquility Package: Digital Controls, 8 multi-colored perimeter lights, backlit waterfall, Heat Stick, R-15 Foam Insulation AND stainless jets,		
Luxury Air Bath	Air Bath with Tranquility Package: Digital Controls, 8 multi-colored perimeter lights, stainless jets, aromatherapy, Heated Blower and R-15 Foam Insulation		
Luxury Plus Bath	Dual Therapy - Air & Whirlpool Baths COMBINED with BOTH Tranquility Packages: Digital controls, stainless steel whirlpool and air jets, 8 multi-colored perimeter lights, back-lit waterfall, aromatherapy, and R-15 Foam insulation		
Available Upgrades	Bluetooth/FM Audio Stainless Slimline Drain Kit Stainless fixtures in your choice of either Classic or Modern Brushed nickel or oil rubbed bronze finish Whirlpool Jets (Air Jets available in white, almond or stainless steel only) In-Line heater (Available on Luxury & Luxury Plus Whirlpool Baths ONLY)		

- Add 1 1/2" to overall height on Whirlpool Jetted Bath
- Add 3" to overall height on Air and Whirlpool Jetted Bath
- Cutout for Platform Installation is 2" smaller than tub dimensions
- Controls are surface mounted near desired pump location
- Hot water supply should be a minimum of 70% of bath capacity

Notes:

- Signature Bath recommends installation by qualified professionals following installation instructions and applicable codes.
- Fittings are not included
- Take measurements from the bath, prior to commencing construction
- All measurements are subject to a variance of 1/2" +/-

You might also consider the SB-14, SB-16 and the SB-17

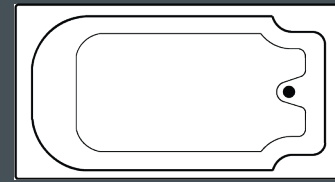

Soaking Tub

Soaker  
SB-13-S

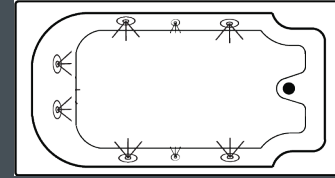

Whirlpool Bath with White or Almond Jets

Whirlpool  
SB-13-W

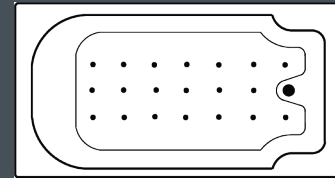

Air Injected Micro Bubble Massage

Air  
SB-13-A

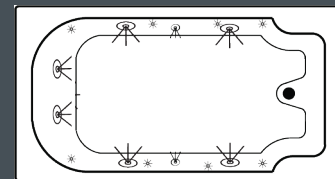

Whirlpool Bath with Stainless Jets  
Multi Colored Perimeter Lights  
& Backlit Waterfall

Luxury Whirlpool  
SB-13-LW

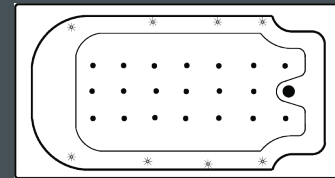

Air Injected Micro Bubble Massage  
Stainless Jets  
Multi Colored Perimeter Lights  
Aromatherapy

Luxury Air  
SB-13-LA

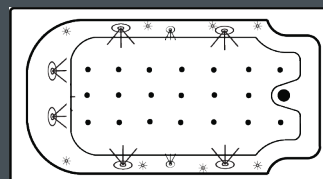

Dual Therapy Whirlpool & Air Bath  
Stainless Whirlpool Jets  
& Micro Bubble Massage Air Jets  
Multi Colored Perimeter Lighting  
Backlit Waterfall  
Aromatherapy

Luxury PLUS  
SB-13-LP