

Sleek, Modern Style with a Comfortable Sloped Back & Arm Rests

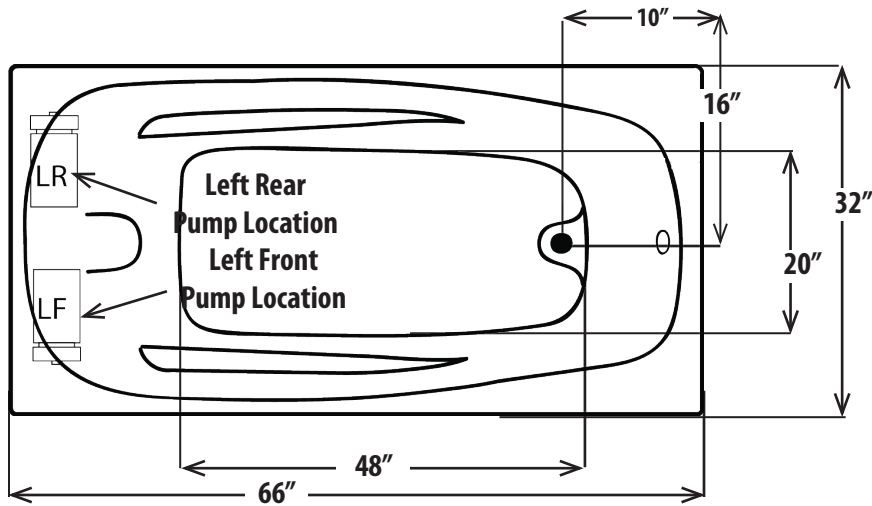
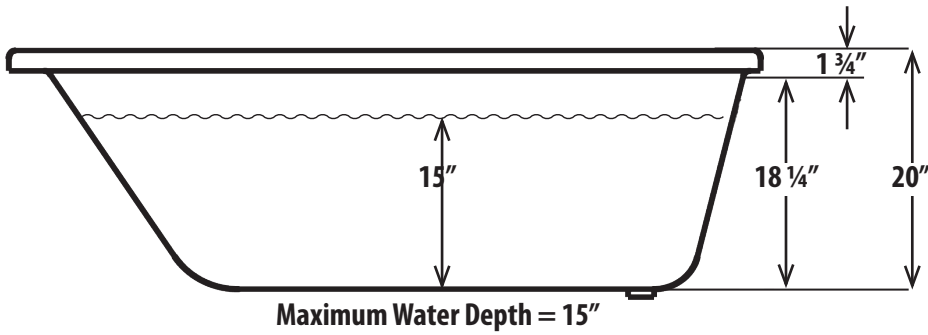

SPECIFICATIONS

Size	66" L x 32" W	Overall Height: 20"	Height to Base of Lip: 18 1/4"
Interior Dimensions	48" L x 20" W	Maximum Water Height: 15"	Drain Location: End
Average Gallon Capacity: 45	Installation Type: Drop In	Long End to Drain Center: 16"	Short End to Drain Center: 10"
Material	Extra Thick High Gloss Lucite® Acrylic with Zero Flex Bottom		
Colors	White, Biscuit, Bone, Almond, Mexican Sand, Sterling Silver, Red & Black		
Electrical Requirements for Luxury Whirlpool, Luxury Air & Luxury Plus (Soaking baths do not require electrical connection)			
Heat Stick	No ELECTRICITY REQUIRED - Water temperature is maintained when pump is on (NOT AVAILABLE ON AIR BATHS)		
Pump / Blower	Single dedicated 120V 20 AMP GFCI protected circuit for both Luxury & Luxury Plus Baths		
Optional In-Line Heater	Requires installation of additional dedicated 120V 15 AMP GFCI protected circuit		
Bath Features			
Whirlpool Bath	8 Hydrotherapy Jets in either white or almond, Pump, Heat Stick, Push Button Controls		
Air Bath	20 Air Injection Jets in either white or almond, Heated Blower, Push Button Controls		
Luxury Whirlpool Bath	Whirlpool Bath with Tranquility Package: Digital Controls, 8 multi-colored perimeter lights, backlit waterfall, Heat Stick, R-15 Foam Insulation AND stainless jets,		
Luxury Air Bath	Air Bath with Tranquility Package: Digital Controls, 8 multi-colored perimeter lights, stainless jets, aromatherapy, Heated Blower and R-15 Foam Insulation		
Luxury Plus Bath	Dual Therapy - Air & Whirlpool Baths COMBINED with BOTH Tranquility Packages: Digital controls, stainless steel whirlpool and air jets, 8 multi-colored perimeter lights, back-lit waterfall, aromatherapy, and R-15 Foam insulation		
Available Upgrades	Bluetooth/FM Audio Stainless Slimline Drain Kit Stainless fixtures in your choice of either Classic or Modern Brushed nickel or oil rubbed bronze finish Whirlpool Jets (Air Jets available in white, almond or stainless steel only) In-Line heater (Available on Luxury & Luxury Plus Whirlpool Baths ONLY)		

- Add 1 1/2" to overall height on Whirlpool Jetted Bath
- Add 3" to overall height on Air and Whirlpool Jetted Bath
- Cutout for Platform Installation is 2" smaller than tub dimensions
- Controls are surface mounted near desired pump location
- Hot water supply should be a minimum of 70% of bath capacity

Notes:

- Signature Bath recommends installation by qualified professionals following installation instructions and applicable codes.
- Fittings are not included
- Take measurements from the bath, prior to commencing construction
- All measurements are subject to a variance of 1/2" +/-

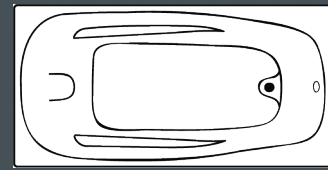

Soaking Tub

SB-19-S
Soaking

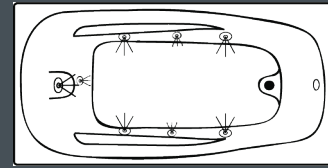

Whirlpool Bath with White or Almond Jets

SB-19-W
Whirlpool

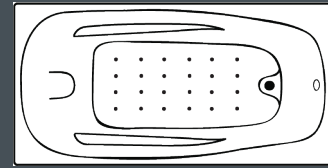

Air Injected Micro Bubble Massage

SB-19-A
Air

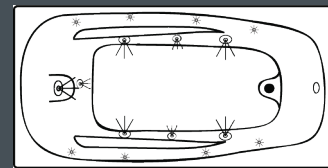

**Whirlpool Bath with Stainless Jets
Multi Colored Perimeter Lights & Backlit Waterfall**

SB-19-LW
Luxury Whirlpool

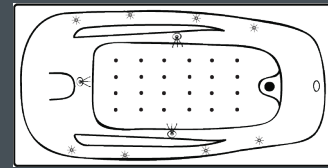

**Air Injected Micro Bubble Massage
Stainless Jets
Multi Colored Perimeter Lights
Aromatherapy**

SB-19-LA
Luxury Air

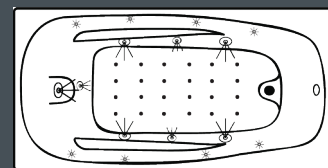

**Dual Therapy Whirlpool & Air Bath
Whirlpool Jets
Micro Bubble Massage Air Jets
Multi Colored Perimeter Lighting
Backlit Waterfall
Aromatherapy**

SB-19-LP
Luxury PLUS

You might also consider the SB-13, SB-14 and the SB-17